

Art. Nr. 2822950

GROUNDPLAN - GRUNDPLAN - PLAN DE MASSE

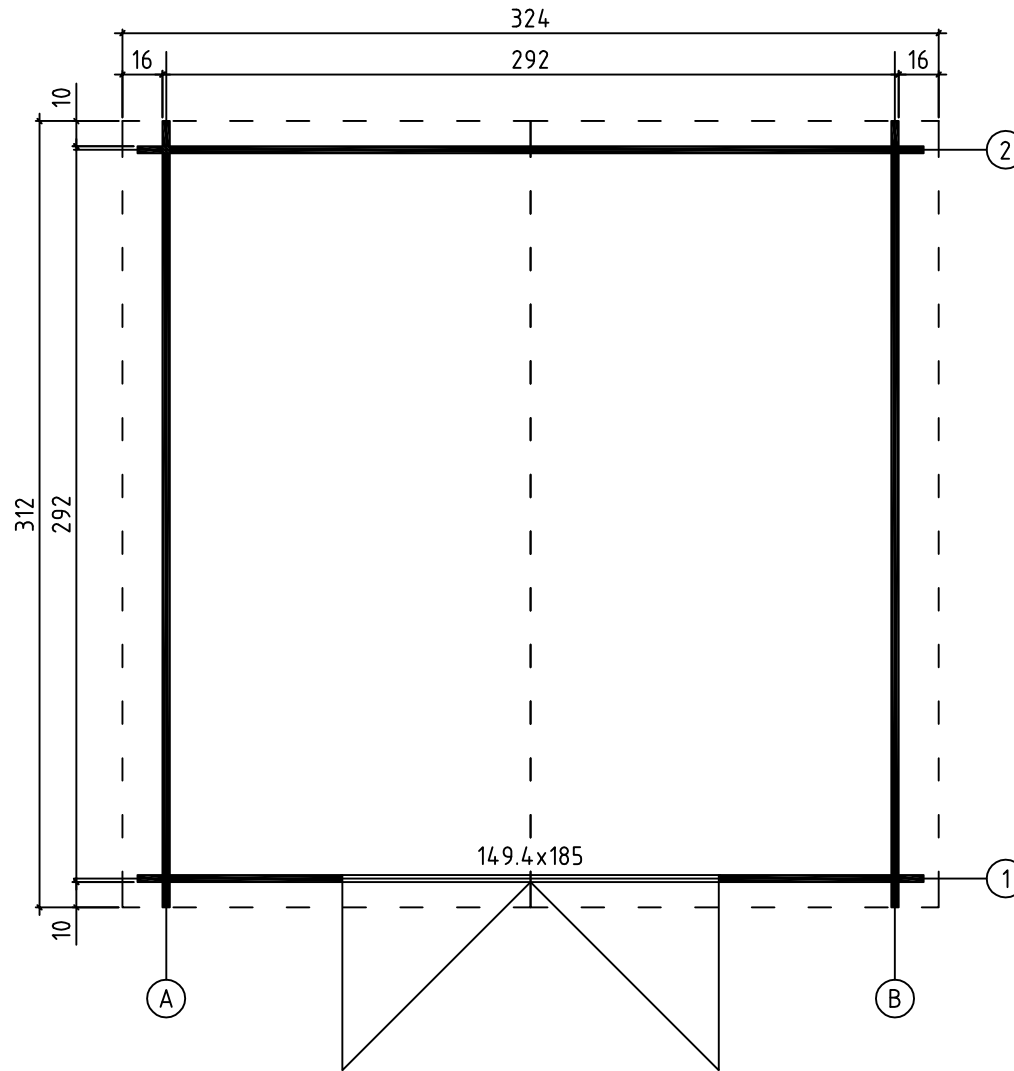

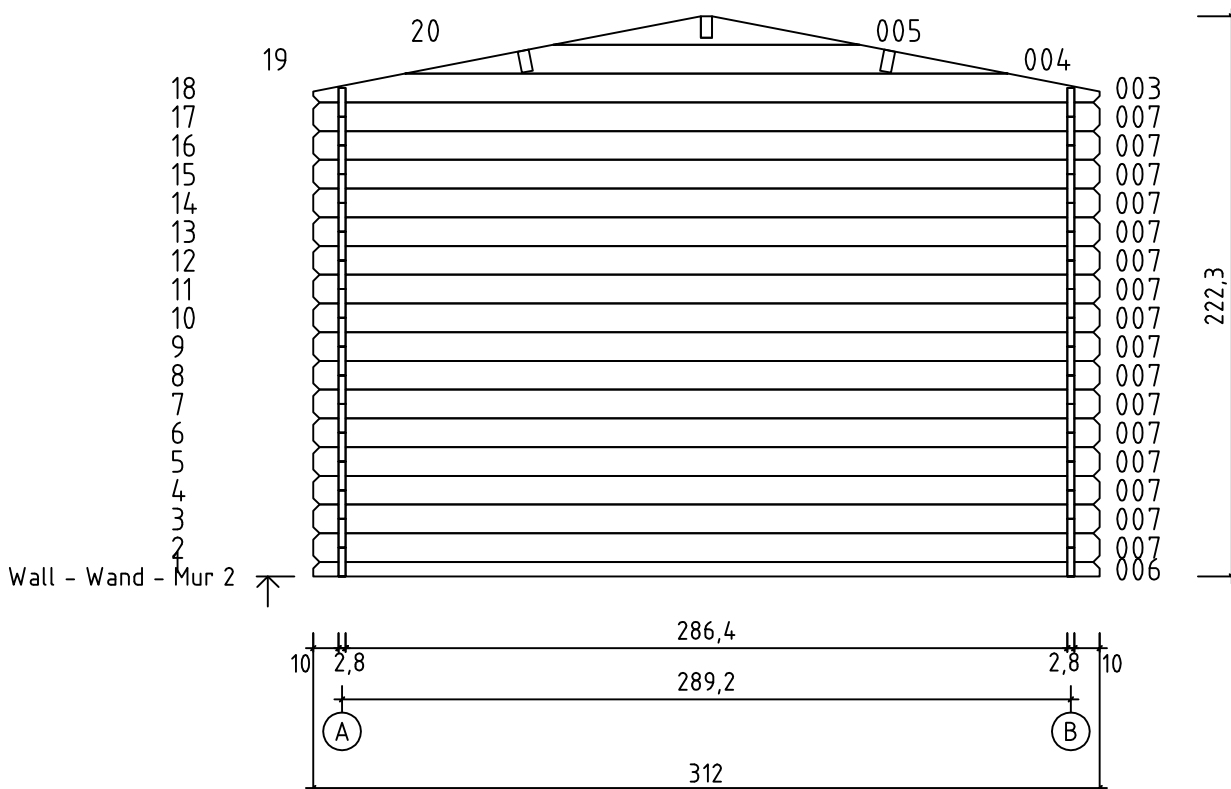

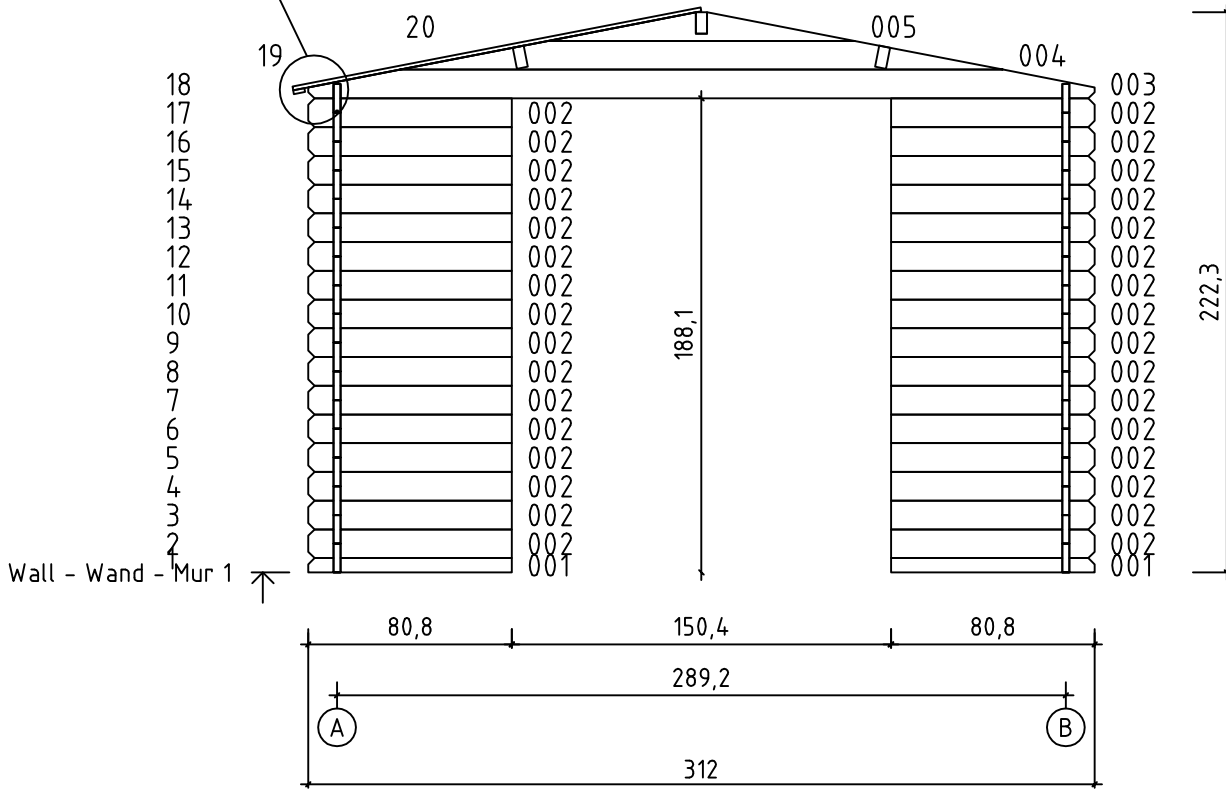
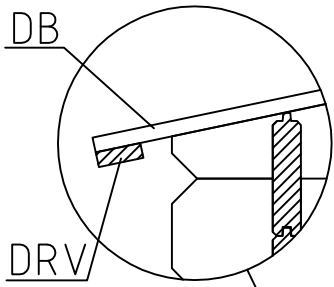



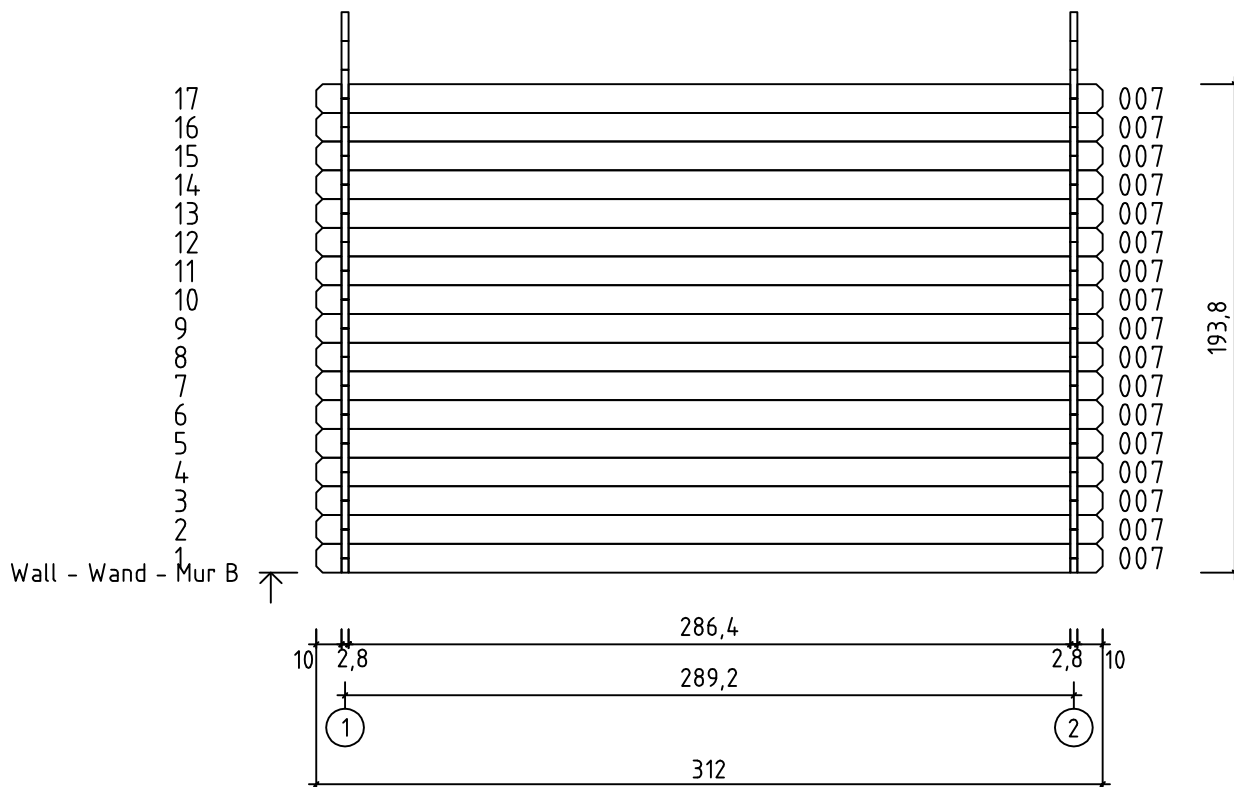
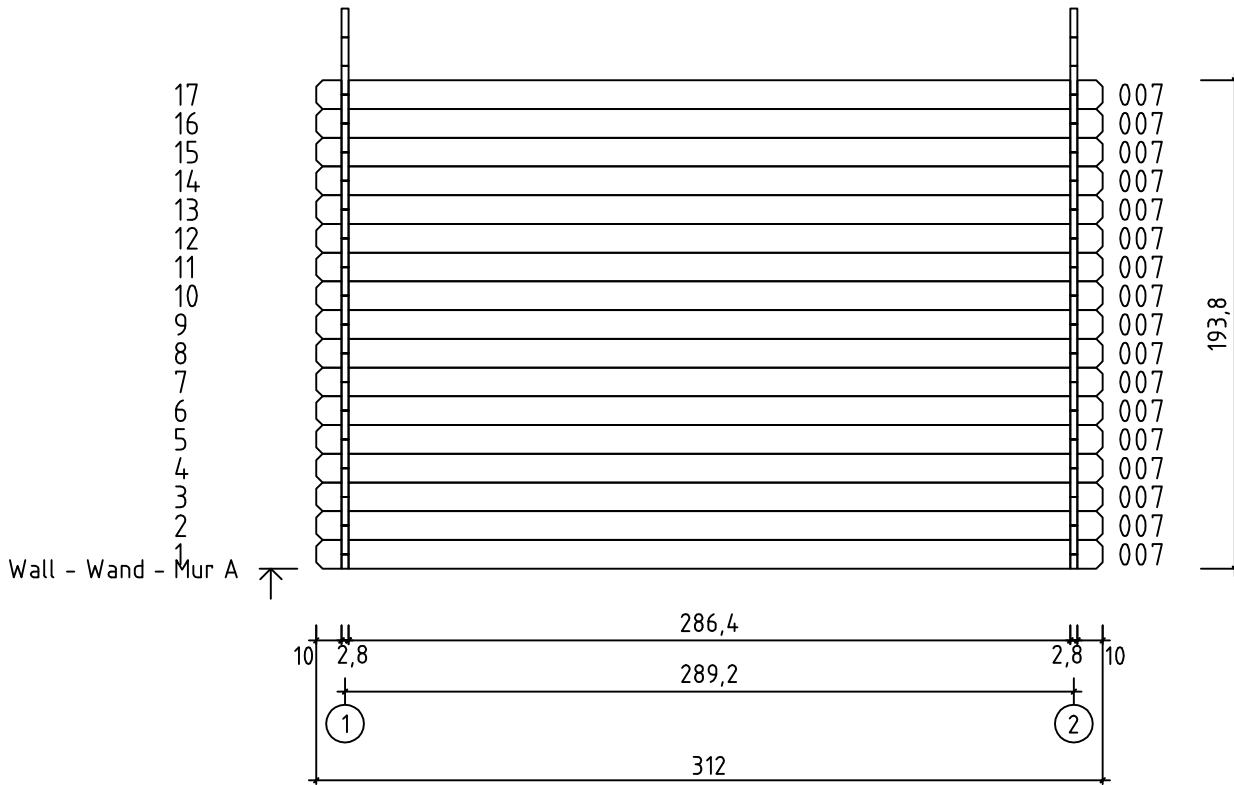



Art. Nr. 2822950

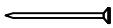

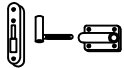
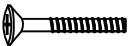



Art. Nr. 2822950

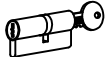
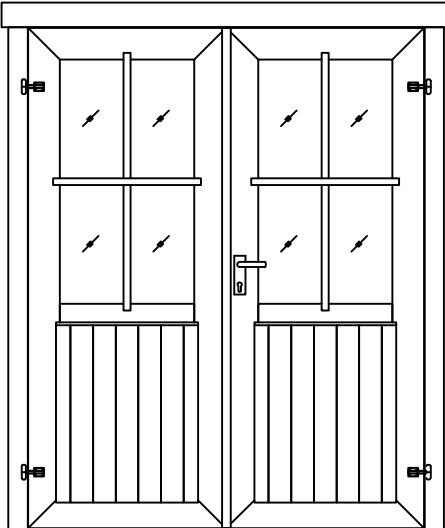

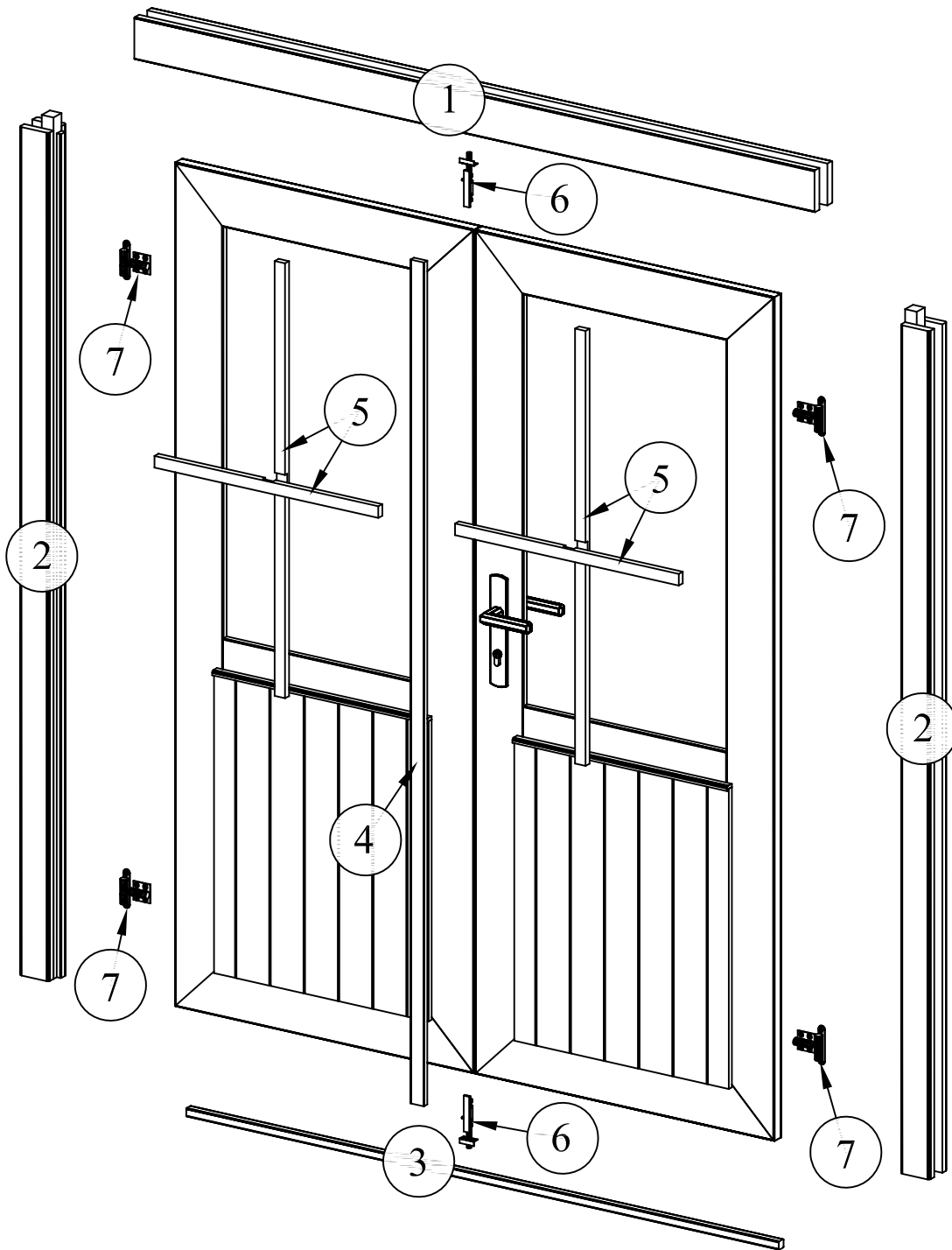
Pos	29.08.2016	Piecelist - Stücklist - Liste des composants Art. Nr. 2822950	5/6	Q.	P. (mm)	L. (mm)
001				2	28x57	808
002				32	28x114	808
006				1	28x57	3120
007				50	28x114	3120
W1-1 W2-1				1 1		
A-PR1				3	44x95	3120
DB	ROOF BOARDS - DACHBRETTER - VOLIGES			70	90x15	1650
	ROOFING FELT FILLET - DACHPAPPENLEISTE - BAGUETTE DE FIXATION DU FEUTRE BITUMEUX			4	15x45	1700
DRV	ROOF EDGE REINFORCEMENT - DACHRANDVERSTÄRKUNG - CORNIERE DE RENFORT DE BORD DE TOIT			2	15x45	3120
KFS-1	STORM PROTECTION - STURMLEISTE - - LATTE ANTI-TEMPETE			4	22x45	2050
	ROOFING FELT (STRIP) - DACHPAPPE (BAHNEN) - - FEUTRE BITUMEUX (BANDE)			4		3220
	GABLE MOULDING - GIEBELLEISTE - - PLANCHE DE RIVE			4	15x120	1700
HS1	SCREW FOR GEORGIAN BARS - SCHRAUBE FÜR SPROSSEN - VIS DE BARRES GEORGIENNE			8	2.5x20	
HS8	SCREW FOR GABLE SEGMENT - SCHRAUBEN FÜR DECKBLATT - VIS POUR FIXATION LOSANGE DE FINITION			4	3.5x35	
HS9	SCREW FOR FIXING DOOR TO THE WALL - SCHRAUBE ZUR BEFESTIGUNG TÜR - ZARGE MIT WAND - VIS DE FIXATION DORMANT DE PORTE			2	3.5x50	
HS9	SCREW FOR GABLE MOULDING - SCHRAUBEN FÜR GIEBELLEISTE - VIS DE FIXATION POUR PLANCHE DE RIVE			24	3.5x50	
HS4	SCREW FOR DOORSTEP - SCHRAUBEN FÜR SWELLE - VIS DE FIXATION DU SEUIL DE PORTE			3	3x30	
HS4	SCREW FOR ROOF EDGE REINFORCEMENT - SCHRAUBEN FÜR DACHRANDVERSTÄRKUNG - VIS POUR RENFORT DE BORD DE TOIT			14	3x30	
HS4	SCREW FOR DOOR FILLET - SCHRAUBE ZUR BEFESTIGUNG TÜRLEISTE - VIS D'ASSEMBLAGE DU CADRE DE PORTE			5	3x30	
HS11	SCREW FOR FIXING BOLT HINGE - SCHRAUBE FÜR TÜRRIESEL - VIS DE FIXATION POUR CHARNIERES ET GONDS DE PORTE			16	4x30	
HS12	SCREW FOR FIXING BOLT HINGE - SCHRAUBE FÜR TÜRRIESEL - VIS DE FIXATION POUR CHARNIERES ET GONDS DE PORTE			12	4x40	
HS13	SCREW FOR DOOR JAMB - SCHRAUBE FÜR TÜRRAHMEN - VIS DE FIXATION POUR MONTANT DE PORTE			2	4x60	
HS18	SCREW FOR ROOF BEAMS - SCHRAUBEN FÜR DACHBALKEN - VIS POUR PANNE DE TOIT			10	5x120	
HS16	SCREW FOR DOOR JAMB - SCHRAUBE FÜR TÜRRAHMEN - VIS DE FIXATION POUR MONTANT DE PORTE			2	5x90	

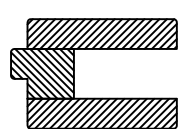
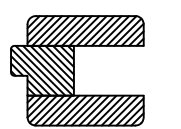
Pos	29.08.2016	Piecelist - Stücklist - Liste des composants Art. Nr. 2822950	6/6	Q.	P. (mm)	L. (mm)
SH28	HAMMER BLOCK - SCHLAGHOLZ - CALLE DE FRAPPE			1		
SFS	NUT FOR STORM PROTECTION - SCHRAUBENMUTTER FÜR STURMLEISTE - ÉCROU POUR LAME ANTI-TEMPETE			8	D6	
NF4	ZN NAIL FOR ROOF - ZN NÄGEL FÜR DACHBRETTER - POINTES DE FIXATIONS DES VOLIGES DE TOIT			224	2x50	
NF5	ZN NAIL FOR ROOFING FELT FILLET - ZN NÄGEL FÜR DACHPAPPENLEISTE - POINTE POUR BAGUETTE FIXATION FEUTRE BITUMEUX			16	2x40	
NF6	ROOFING NAILS FOR ROOFING FELT - NÄGEL FÜR DACHPAPPE - POINTE DE FIXATION POUR FEUTRE BITUMEUX			110	2.8x15	
	MALE BOLT HINGE FOR DOOR - TÜRRIEGEL - PARTIE MALE DE CHARNIERE DE PORTE			4	DIN15-57	
BFS	BOLT FOR STORM PROTECTION - BOLZEN FÜR STURMLEISTE - VIS POUR LAME ANTI-TEMPETE			8	6x60	
TL	LATCH BOLT FOR DOUBLE DOOR - TORRIEGEL - LOQUET POUR DOUBLE PORTE			2		90
GS	GABLE SEGMENT - DECKBLATT - LOSANGE DE FINITION			2		
DFS	WASHER FOR STORM PROTECTION - DICHTSCHEIBE FÜR STURMLEISTE - RONDELLE POUR LAME ANTI-TEMPETE			8	D6	
TL4	DOOR HANDLE FITTINGS - TÜRGRIFF - SET DE GARNITURES DE SERRURE DE PORTE			1		
TL5	SET OF DOOR LOCK COVERS - SCHLOSSBLENDEN - SET DE GARNITURES DE SERRURE DE PORTE			1		
	CYLINDER LOCK - ZYLINDERSCHLOSS - CYLINDRE DE SERRURE			1	30/30	
	DOOR - TÜR - PORTE 1494x1850 SGA+28	TUK.2.044.SVP.MX28		1		
						

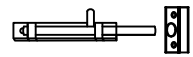
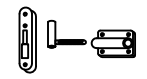

Pos	Piece list - Stückliste - Liste des pièces	Q.	P (mm)
1		1	66x100
2		2	66x80
3		1	18x18
4		1	13x32
5		4	15x25
6		2	
7		4	

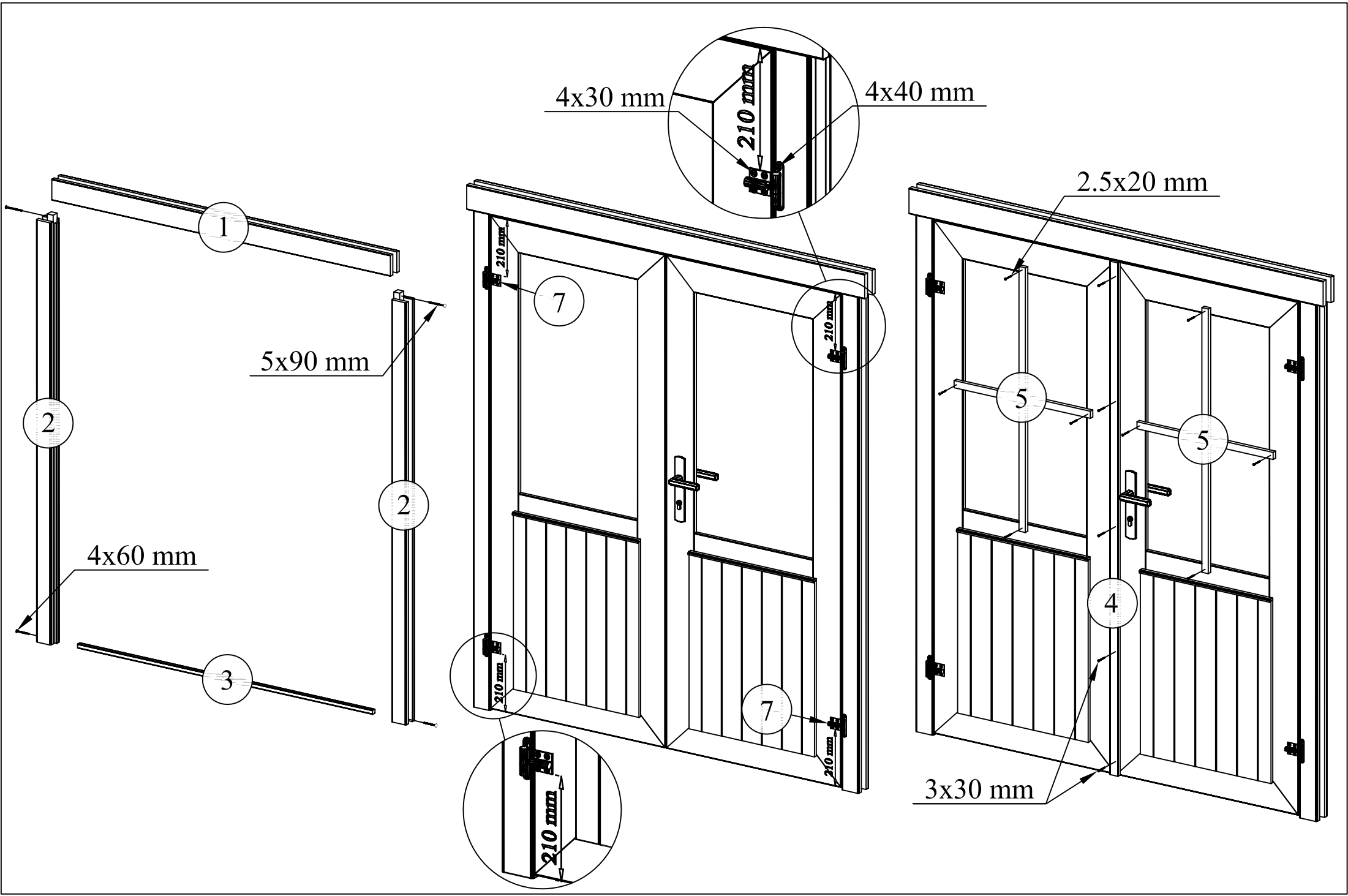

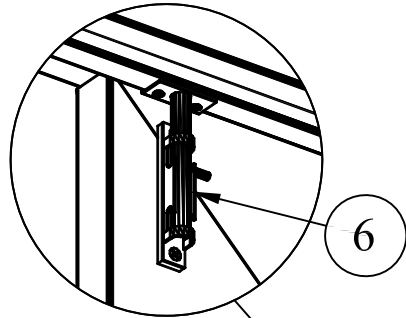

3x30 mm

3

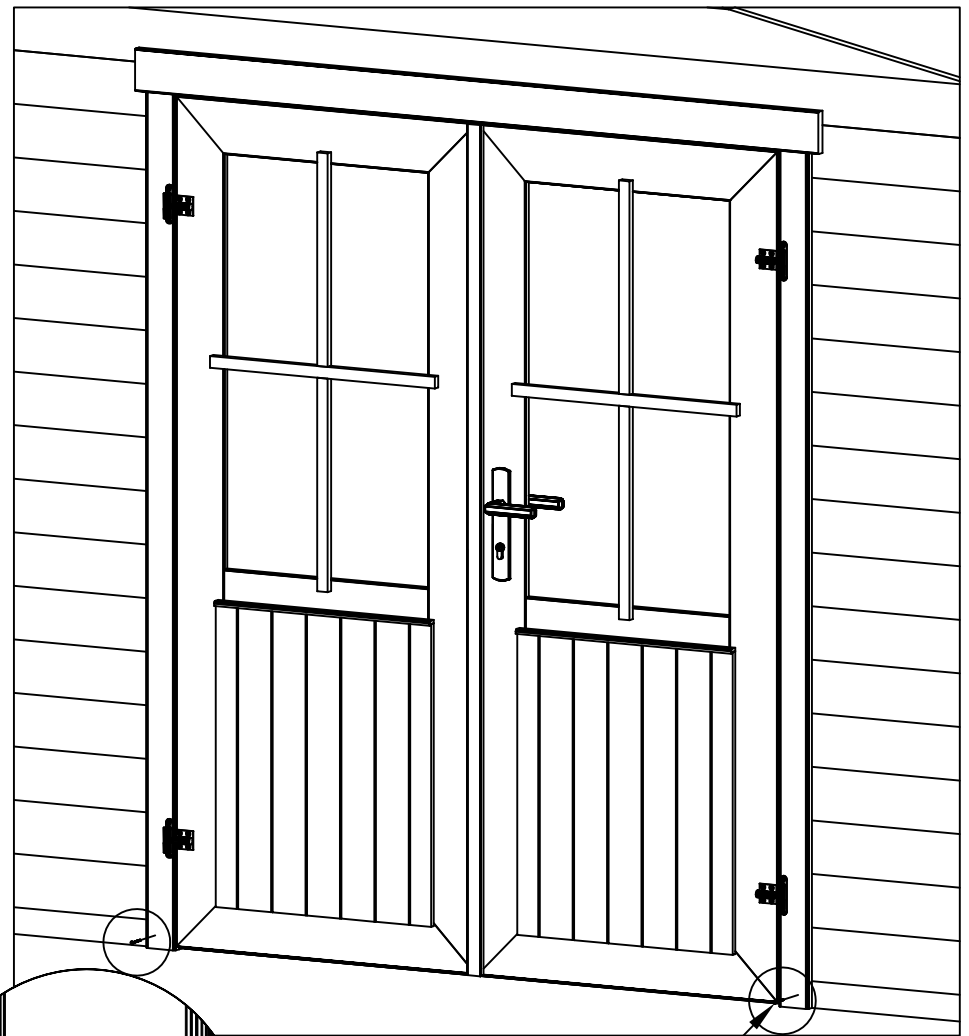

3.5x50 mm

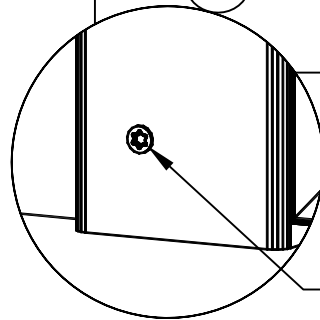

3.5x50 mm